

STANDARD SPECIFICATION

Model NSX-2100H

Trace Nitrogen, Sulfur and Halogen Analyzer system utilizing oxidative sample combustion.

Trace Elemental Analyzer NSX-2100H	
Samples	Solid, Non-aqueous liquid, Gaseous, LPG
Analytical method	Oxidative Pyrolysis and detection
Furnace	Max. 1,100°C, two part independent controlled. Horizontal electric furnace HF-210. Open/Close type.
Detector	Ultraviolet Fluorescence (UVFL) for Sulfur - Model SD-210. temperature controlled cell
	Chemiluminescence (CLD) for Nitrogen - Model ND-210. temperature controlled cell
	Microcoulometry for Chlorine and Sulfur - Model MCD-210.
Measuring range	UVFL-Sulfur solid: 0.05-10,000µg/g, liquid: 0.05 - 5,000µg/ml
	CLD-Nitrogen solid: 0.5-5,000µg/g, liquid: 0.2 - 5,000µg/ml
	Coulometry Chlorine 0.01 - 500µg (0.1 - 5,000µg/ml)
	Coulometry Sulfur 0.05 - 50µg (0.5 - 500µg/ml)
Typical sample size	Solid 30mg (up to 150mg)
	Non-aqueous liquid 50µl (up to 100µl)
Measuring time	UVFL/CLD 3-10min. (simultaneous Nitrogen/Sulfur available)
	Coulometry less than 10min
Gas	Ar and O ₂
Others	Vacuum pump for ND-210
Electric	100-240VAC 50/60Hz

Module specification	Power consumption	Dimension WDH mm	Mass
Furnace HF-210	1000 VA	320 x 430 x 500	25Kg
Detector SD-210	150 VA	220 x 375 x 500	21Kg
Detector ND-210	300 VA	220 x 375 x 500	22Kg
Detector MCD-210	150 VA	220 x 375 x 500	14Kg

PC	
OS	Microsoft Windows® 10 professional 64bit
Processor	2.4 GHz or more
Memory	2 GB or more
HD	160 GB or more
Drive	one CD-ROM or DVD disk drive
Display	15 inches display or more
Printer	compatible to OS
Port	1 serial port (RS-232C, D-sub9)

● Configuration and dimension examples (unit: mm)

Two detector system with solid/liquid sampler

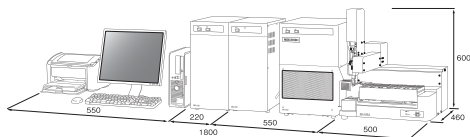

One detector system with ABC+liquid sampler

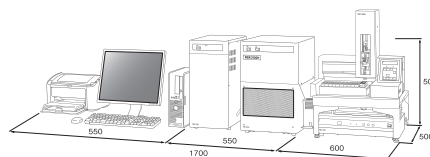

Note: Follow instructions in manuals to correctly install, connect and operate the instruments. Contents of catalogues are subject to change without prior notice when improvements are made in performance. The actual color of the goods may appear different from color printed. All screen images are simulated. *Company and product names contained herein are the trademarks or registered trademarks of the company concerned.

Nittoseiko Analytech Co.,Ltd.

7-10-1 Chuo-rinkan, Yamato, Kanagawa 242-0007, JAPAN

Tel: +81(0)46-278-0056

URL: <https://www.mccat.co.jp/global>

CAT No.05090520041E

NSX-2100H

Trace Elemental Analyzer Horizontal System



Nittoseiko Analytech Co.,Ltd.

NSX-2100H

Fuel, Oil, Lubricant, LPG, Plastics, Powder, Rubber, Coal, Inorganics for the industries of Energy, Chemical, Environment, Electronics, Automobile.
Oxidative combustion technique has been widely recognized and utilized for various purposes.

NSX-2100H: 4 different detectors can be connected to 1 furnace depending on your requirement.

- Nitrogen: Chemiluminescence.
- Sulfur: UVFL, Coulometry.
- Chlorine: Coulometry.
- S, F, Cl, Br, I: Ion Chromatography.

● 40 boats for Solid automation



● Liquid handle in solid sampler



● Open/Close furnace for daily maintenance



■ TWO RANGE SELECTION, EASY OF USE.

Simpler sensitivity selection of detector.

$\mu\text{g/g}$	Sulfur	Nitrogen
High sense	0.05 - 10	0.5 - 50
Low sense	1 - 10,000	1 - 5,000

■ HANDLING LIQUID WITH SOLID SAMPLER.

Solid sampler ASC-240S can handle liquid sample by liquid port. No need to change set up for urgent sample request.

■ EASY DAILY MAINTENANCE.

Unique Open/Close furnace provide easier daily preparation before start.

■ LOW RUNNING COST.

Less gas consumption than before by newly designed detector.

■ MODULARITY, FLEXIBILITY.

Customized system for today's requirement and for future possibility.

Sample injectors



Detectors



Furnace



C-IC prep station



Software

Intuitive advanced software will increase usability of protection, operation, and integration.

■ PROTECTION

Three level login function can protect method and data from unforeseen change.



■ OPERATION

[Stand by] heating, [Auto shut down] function increase operability and save energy.



■ REAL TIME MONITOR OF PEAK PROFILE

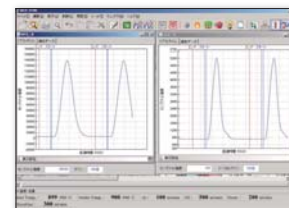

■ CUSTOMIZABLE DISPLAY LAYOUT AS REQUIRED, SIMPLE or DETAILED.

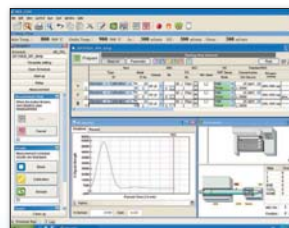

■ LINK to LIMS

Software Add-in operation will help data handling easier. It can output result data simultaneously in various style as serial port (RS-232C) or file format (CSV, TXT).

■ RECALCULATION, SAVING TIME, SAMPLE and WASTE

Stored peak can be recalculated, reduce re-analysis.

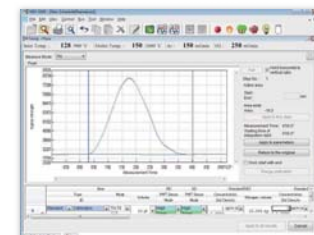

■ STABILITY CHECK

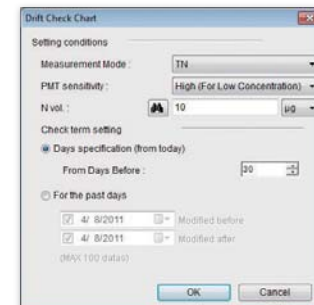

● Methods in Petroleum Products

Element	Sulfur	Nitrogen	Chlorine	Sulfur
Method of detection	Ultraviolet Fluorescence	Chemiluminescence	Coulometric titration	
ASTM	D5453, D6667, D7183, D7551	D4629, D5176, D6069, D7184, D5762	D4929, D5808, D6721, D7457	D3120, D3246
UOP	987-11, 988-11	981-10, 971-00, 936-95	910-07	—

MEASUREMENT Principle

UVFL Sulfur (SD-210 detector)

Sulfur Measurement

The sample is injected with argon carrier gas into the pyrolysis tube of high temperature (900 to 1000°C). Sulfur compounds in the sample are pyrolyzed and oxidized with O₂ gas.



The produced SO₂ gas is excited (SO₂^{*}) by irradiating the ultraviolet ray $\nu 1$ (190-230nm). Then, SO₂^{*} emits the energy (fluorescent ultraviolet ray) and returns to the ground state.



This fluorescent ultraviolet ray $\nu 2$ (300-400nm) is received by the photomultiplier tube and AREA value is obtained. The sulfur concentration is obtained by calibration curve preliminarily drawn with the standard solution.

UVFL Sulfur Applications

Sample	Sample size (μl)	Rep	Sulfur		Nitrogen	
			Result (ppm)	RSD (%)	Result (ppm)	RSD (%)
Naphtha	10	5	181	0.6	1.9	2.9
Light Oil	10	3	133	0.6	10	1.9
Kerosene	10	3	25	1.2	3.5	1.9
Gasoline	10	3	145	1.8	35	1.8
Lubricant Oil	10	5	2870	1.2	5.6	1.2
Heavy Oil	10	3	1340	0.5	99	0.2
Pulp	5mg	3	206	1.6	420	0.7
Polybutylene Terephthalate (PBT)	30mg	5	303	2.6	3.3mg	3.6

SD-210 Detector

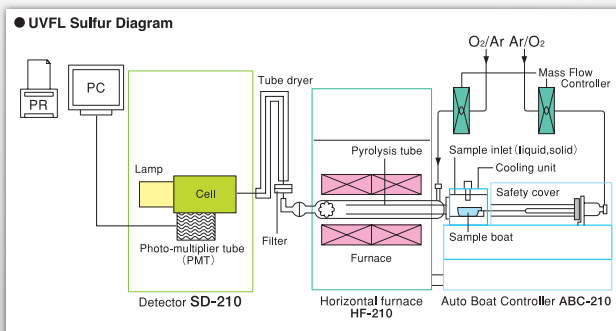

Chemiluminescence Nitrogen (ND-210 detector)

Nitrogen Measurement

Sample is injected into a high-temperature (900 to 1000°C) pyrolysis tube by argon carrier gas. After nitrogen compounds in the sample are pyrolyzed, it is combusted, oxidized, and converted to nitric oxide (NO). After removing moisture from the combustion gas by a dehumidifier (tube dryer), the following oxidation reaction occurs by reaction of NO with ozone.

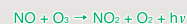

By this reaction, 590 to 2,500nm wavelength light is generated. The optical intensity of this light is proportional to the NO concentration at a wide frequency range. After emitted light is detected by a photomultiplier tube and signal processing is run, an area value is obtained. Using the relation between area and concentration (calibration curve) obtained from standard solutions, the total nitrogen concentration in the sample is calculated. Though some samples generate interfering substances such as SO_x and CO in the process of decomposition to NO, there is little influence on measurement by chemiluminescence method by reduced pressure method.

Chemiluminescence Nitrogen Applications

Sample	Sample Size (mg)	Rep	Result (ppm)	RSD (%)
Light Oil	20μl	3	52	2.1
Heavy Oil	20μl*	3	2350	1.6
Lubricant Oil	20μl*	3	375	1.8
Polyethylene	12	5	27	3.8
Polycarbonate	13	5	2.5	4.5
Epoxy resin	11	5	31	1.2
Pulp	3	5	3750	2.1
Toner	8	5	355	1.5
Rubber	5	3	270	1.2

ND-210 Detector with Vacuum Pump



*Diluted by toluene

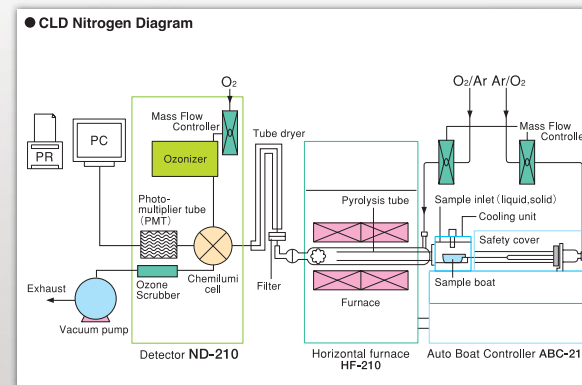

Microcoulometry (MCD-210 detector)

Chlorine Analysis

Samples are combusted in an argon/oxygen atmosphere. The resulting hydrogen chloride is led into a titration cell where it is automatically titrated by silver ions generated coulometrically. The amount of chlorine is calculated from the quantity of electricity required for the titration.

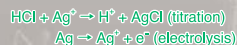

Sulfur Analysis

Samples are combusted in an argon/oxygen atmosphere. The resulting sulfur dioxide is led into a titration cell where it is automatically titrated by triiodide ions generated coulometrically. The amount of sulfur is calculated from the quantity of electricity required for the titration.

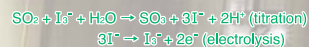

Microcoulometric Titration Diagram

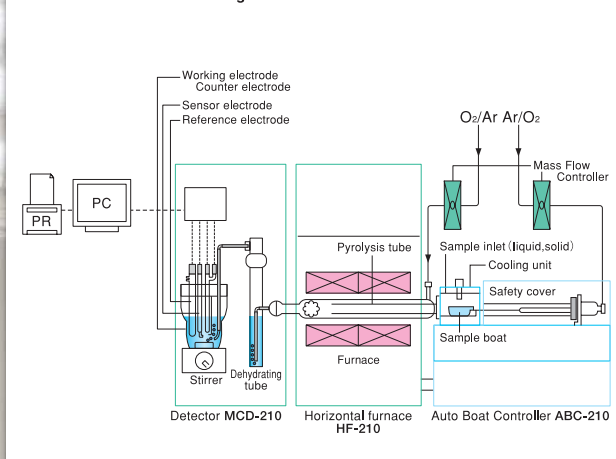

Microcoulometry Applications

Chlorine

Sample	Sample Size (mg)	Rep	Result (ppm)	RSD (%)
Toluene	100μl	3	0.14	12.3
Naphtha	100μl	3	0.17	14.1
Lubricant Oil	50μl	3	34	4.2
Crude Oil	10	3	7.5	3.2
Rubber	10	3	580	2.1
Polycarbonate	20	3	7.9	3.4
Foil	20	3	5.5	6.5
Waste Oil	15μl	3	3600	3.2
Cement	10	3	280	4.1

Sulfur

Sample	Injection (mg)	Rep	Result (ppm)	RSD (%)
Lubricant Oil A	5μl	3	1.20%	3.5
Lubricant Oil B	10μl	3	0.76%	3.5
Lubricant Oil C	10μl	3	520	4.3
Rubber	15	3	740	3.2
Resin	15	3	130	2.4
Crude Oil	5	3	120	3.1
Coal	10	3	320	6.1
Coke	10	3	570	3.2

MCD-210 Detector



APPLICATION and OPTION

■Prep-station for combustion-IC (Sulfur and Halides) analysis.

Measuring Principle

After samples are thermally digested in Argon atmosphere they are combusted with oxygen and H₂O. Sulfur in the samples changes to SO_x and Halogens turn to Hydrogen Halide and Halogen gas. These elements will be trapped by the absorbent solution, then injected for IC analysis.

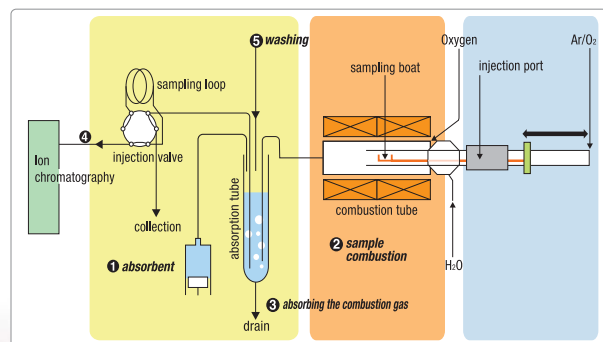
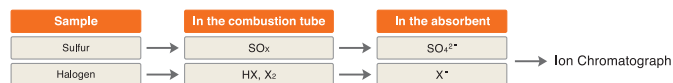

Process Flowchart

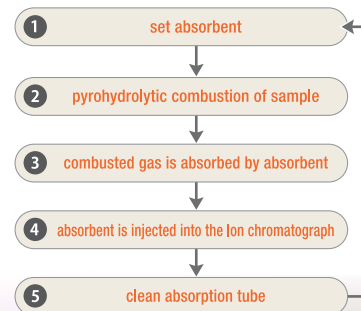

ASTM: D5987, D7359

ISO:2828

JIS: K7392, R1616, R1603, Z7302

KS: M0180

JEITA: ET-7304A

UOP: 991-11

■Gas Injector Model GI-220

Operator safety in flammable gas handling and automatic injection.



MODEL	GI-220 Gas injector
Sample	Non-pressurized gas, Volatile liquid
Injection	10µl for liquid max.100 ml by syringe pump for gas
Carrier	Argon
Heat	80°C for liquid
Power	100 -240VAC, 50/60Hz, 70VA
Dimension	180(W) x 360(D) x 500(H) mm
Mass	13kg

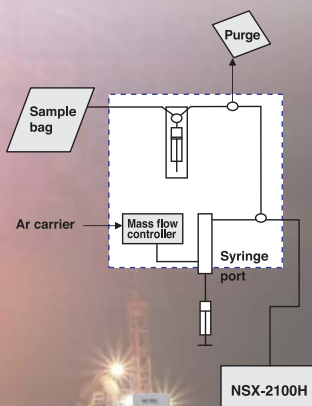

OPTION

■ABC-210



MODEL	ABC-210 Auto Boat Controller
Sample	Solid, Liquid
Amount of sample	Solid 150 mg Liquid 100 µl
Boat	quartz, disposable ceramic
Boat cooling	Peltier
Power	100 - 240VAC, 50/60Hz, 40VA
Dimension	445(W) x 250(D) x 180(H) mm
Mass	9 kg

■ASC-270LS



MODEL	Automatic sample changer for solid and liquid samples
Sample	Solid, Liquid
Amount of sample	Solid 150mg Liquid 100µl
Boat, number of sample (Solid)	Ceramic, 49 pos.
Vial, number of sample (Liquid)	4ml: 84 pos, 2ml: 120 pos.
Boat cooling	Electronic cooling
Power	100-240VAC, 50/60Hz, 192VA
Dimension	500 (W) x 460 (D) x 600 (H) mm
Mass	27 kg

■ASC-250L



MODEL	ASC-250L Liquid sample changer
Sample	Liquid (non-aqueous, aqueous)
Injection	max 150µl (depend on sample)
Inj. speed	0.4 - 50µl/sec (depend on sample)
number	50pos in each 2, 4, 6ml vial tray.
Power	100 - 240VAC, 50/60Hz, 180VA
Dimension	460(W) x 320(D) x 470(H) mm
Mass	16 kg

■GI-210



MODEL	GI-210 Gas injector
Sample	Non-pressurized gas, Volatile liquid
Injection	10µl for liquid, 10ml for gas
Carrier	Argon
Heat	80°C for liquid
Power	100 - 240VAC, 50/60Hz, 20VA
Dimension	220(W) x 200(D) x 110(H) mm
Mass	4kg

OTHER OPTION

■GA-211 gas absorption unit for Ion Chromatography analysis



Elements	Sulfur and Halogen compounds
Function	gas absorption of pyrohydrolytic combusted sample
Sample introduction to analyzer	loop, 6-way valve
Absorption tube	10,20 ml
Dispenser	5ml gastight syringe pump
Drain	peristaltic pump
Sample line	PTFE, PEEK
Communication	contact signal to analyzer
Power	100 - 240VAC, 50/60Hz, 50VA
Dimension	250(W) x 430(D) x 500(H) mm
Mass	22Kg

■ES-211



MODEL	ES-210 External Solution Selector
Sample	Liquid
Number of sample	max 4
Sample injection	PC control

*Some options are in preparation, please ask local distributor.



WolfLabs

Pricing on any accessories shown can be found by keying the part number into the search box on our website.

The specifications listed in this brochure are subject to change by the manufacturer and therefore cannot be guaranteed to be correct. If there are aspects of the specification that must be guaranteed, please provide these to our sales team so that details can be confirmed.

www.wolflabs.co.uk

Tel : 01759 301142

Fax : 01759 301143

sales@wolflabs.co.uk

Please contact us if this literature doesn't answer all your questions.